

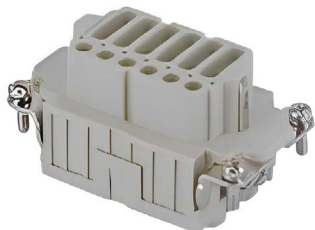

**RICAMBI
FRUTTO FEMMINA A MOLLA 18 POLI**

CENTRALINE DI TERMOREGOLAZIONE

FRUTTO FEMMINA A MOLLA 18 POLI



FRUTTO FEMMINA A MOLLA 18 POLI,
connessione con morsetto a molla, 18 poli + PE, 10 A
400 V 6 kV 3, grandezza "57.27"

DISEGNI A CATALOGO

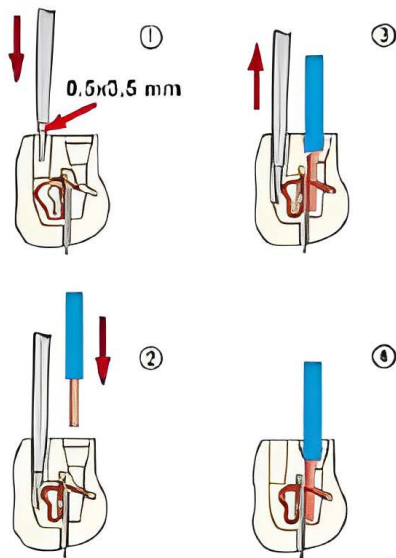
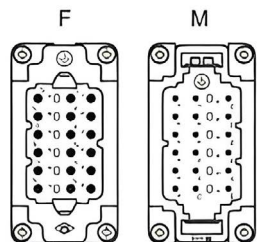
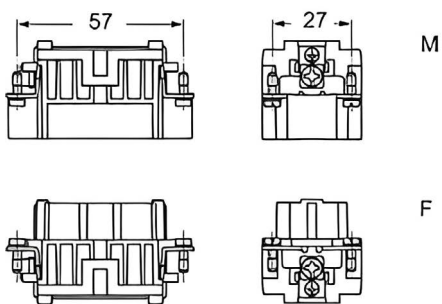



**RICAMBI
FRUTTO FEMMINA A MOLLA 27 POLI**

CENTRALINE DI TERMOREGOLAZIONE

FRUTTO FEMMINA A MOLLA 27 POLI



FRUTTO FEMMINA A MOLLA 27 POLI,
connessione con morsetto a molla, 27 poli + PE, 10 A
400 V 6 kV 3, grandezza "77.27"

DISEGNI A CATALOGO

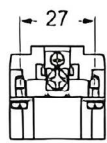
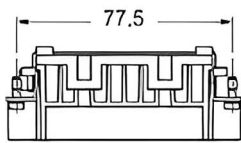

M

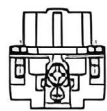
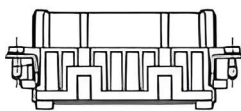

F

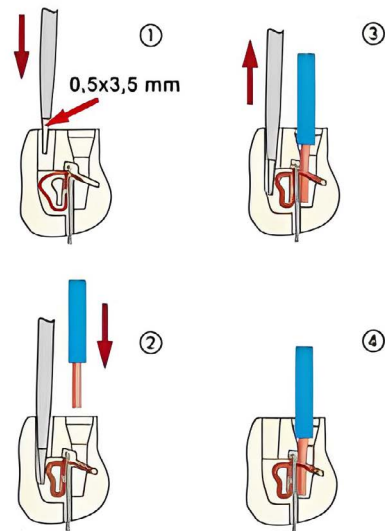
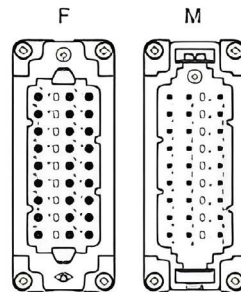



www.eleNorm.com